

B15 T H PE

by Jordi Veciana, 2014

Suspension lamp. Aluminium structure, graphite anodized. Extruded transparent glass diffuser. Dimmable and no dimmable options.

Lámpara de suspensión. Estructura en aluminio anodizado grafito. Difusor de cristal extruido transparente. Versiones dimable y no dimable.

Type: Suspension lamp

Tipo: Lámpara de suspensión

Environment: Indoor

Ámbito de utilización: Interior

Structure: Aluminium

Estructura: Aluminio

Diffuser: Glass

Difusor: Cristal

Voltage

Voltaje: 230 V

Supply: Terminal strip

Alimentación: Regleta



Cable length

Longitud de cable: 250 cm

Light Source / Fuente de luz:

B15 T H PE dimmable 2 x G5: 54 W - 2700 K

B15 T H PE 2 x G5: 28 W - 2700 K 

 5.5 kg
 9.0 kg

B15 T H PE



121000300023 **dimnable electric group graphite** / equipo eléctrico grafito dimable

121000301023 **electric group graphite** / equipo eléctrico grafito

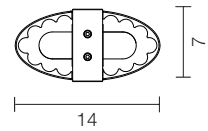
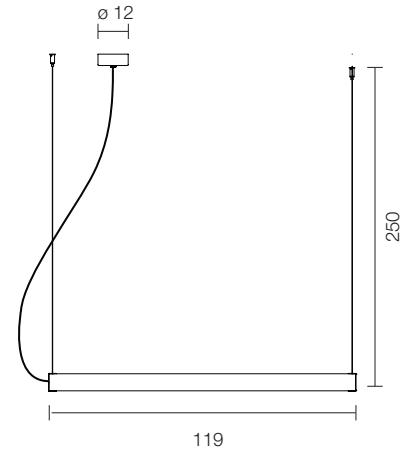
606000000019 **glass diffuser transparent** / difusor cristal transparente



Profile detail / Detalle perfil

CE   IP-20