

## SPEERS ARM C

By David Abad



### Description:



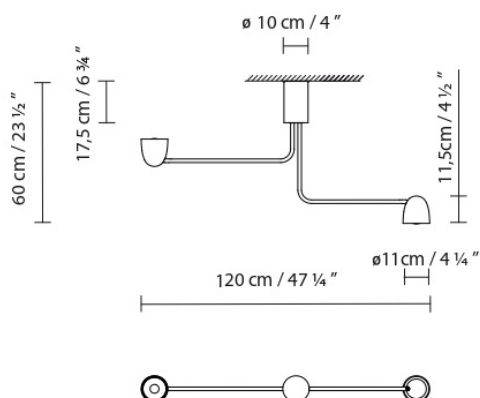

Ceiling lamp with two metal arms that come in textured matte black or white. These arms are combined with two sizes of articulated shades: L and S. The L shade is made in aluminum and available in solid textured matte white or black. The S shade is made in satin brass with a textured matte white finish on the outside, or in satin copper with a textured matte black finish on the outside. The Speers Arm C lamp is equipped with a high-luminance LED light source. It includes a glass lens that focuses the light and enhances its luminous efficiency.

### SPEERS ARM C SHADE S

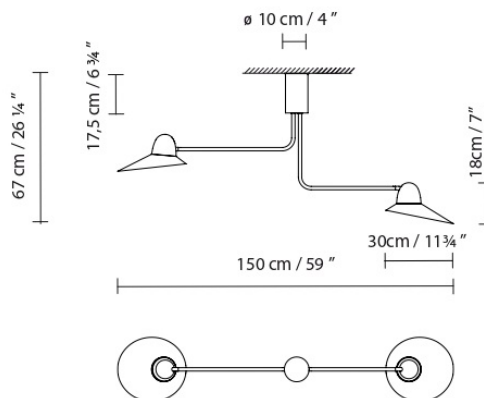





### SPEERS ARM C SHADE L









**PANTALLA S:**   White (matte) / Brass (satin)   Black (matte) / Copper (satin)

**PANTALLA L:**  White  Black

**BODY:**  Black

CODE	LAMP	LIGHT SOURCE	DIM		BULB	
757102	SPEERS ARM SHADE S BLACK/COPPER+					
757107	SPEERS ARM SHADE L BLACK+	LED 9W 1100lm 500mA 2700K CRI≥90 230V	PHASE CUT	A++		1,75 <b>LED A+</b>
757101	SPEERS ARM SHADE S WHITE/BRASS+					
757106	SPEERS ARM SHADE L WHITE+					
757422	SPEERS ARM C BODY BLACK+	LED 9W 1100lm 500mA 2700K CRI≥90 230V	PHASE CUT	A++		<b>LED A+</b>

    DIM  SPEERS ARM C  SPEERS S  SPEERS F

  SPEERS W

### Collection:



Designer

[grupoblux.com](http://grupoblux.com)