

# **B.lux**

Anvil System





# B.lux

---

## Manufacturers of contemporary design lamps

Our business adventure began in 1980. At that time the concept of design was only vaguely appreciated in our area: the Basque Country. This, together with a very scarce local market for this type of product, spurred us towards internationalisation at a very early stage.

We hit the international market with a set of indispensable collaborators: our product designers. In 1980-1981 we worked with Guillermo Capdevila, one of the promoters of design in Euskadi. He was the creator of the Blux System, a collection of lamps that marked a shift in B.lux's product strategy.

Nostalgia and market trends prompt us today, 35 years later, to rerelease this family of lamps, defined by their simple shapes and conforming to the patterns of the English school of Design. Proudly returning to our origins.

The location of our facilities, in a very special natural enclave, also makes its mark on the lamps we produce.

Lamps like the Keshi employ materials that are internationally coveted, like black marble from the Markina quarry, located close to our 5,000-m factory.

It is precisely our role as manufacturers, very unusual today, which allows us to endow our products with a special quality, as we employ the finest maximum manufacturing processes at our facilities.

Our proximity to Bilbao, which has become an international landmark city in the fields of Architecture and Design, has also shaped our lighting catalogue, thanks to our participation in high-profile lighting projects in the City of Design, according to UNESCO.

Thus, each and every one of the lamps making up our catalogue has a story and a reason for being. These stories reinforce our identity, forged over 35 years of history.



### Description:

Surface or suspended recessed lighting system made from extruded aluminium. Can be installed with continuous LED lighting modules with an opal diffuser (LED Line), with LED modules consisting of two or four spots (LED Module), or with LED spotlights (LED Spotlight and LED Spot S, available with anti-glare rings and honeycomb panel). The Anvil system also allows adding spherical diffusers made from white, opal glass that can be attached to the rail (Sphere C) or suspended (Sphere S). The Anvil System profile is available in several finishes: matte white, matte black, natural oak and natural walnut.

### Materials:

Aluminium

### Finishes:

White (matte)



Black (matte)



Natural oak



Walnut



### Certifications:

CE EAC

IP20

Clase I

110 - 240V

### CODE:

851940 Anvil System Suspension/Surface Profile Black (1M)

851941 Anvil System Suspension/Surface Profile White (1M)

851942 Anvil System Suspension/Surface Profile Oak (1M)

851943 Anvil System Suspension/Surface Profile Walnut (1M)

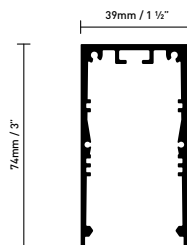

### Light source:

LED Line (LED included)

A+

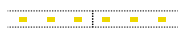

LED Module (LED included)

A+

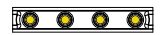

LED Spotlight (LED included)

A+



LED Spot S (LED and driver included)

A+



Sphere C/S (LED and driver included)

A+



### CODE:

851950 Anvil System Recessed Profile Black (1M)

851951 Anvil System Recessed Profile White (1M)

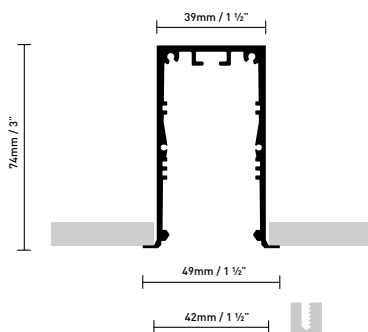

### Light source:

LED Line (LED included)

A+



LED Module (LED included)

A+

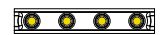

LED Spotlight (LED included)

A+



LED Spot S (LED and driver included)

A+



Sphere C/S (LED and driver included)

A+

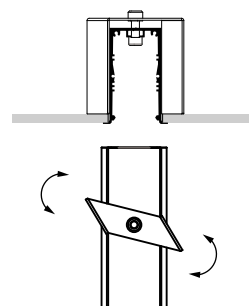

\* Minimum depth: 110mm.



### Anvil System LED Line

Continuous LED light module with opal diffuser, for its integration into the Anvil System. Finishes: matte white or matte black.

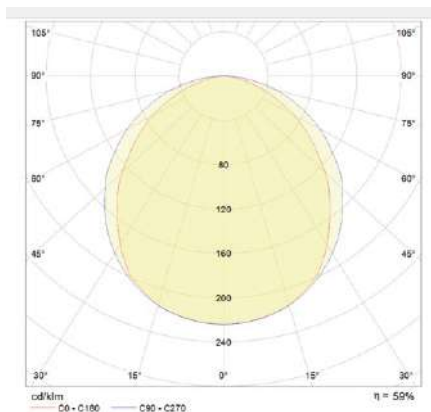
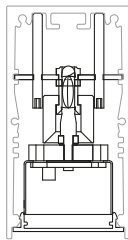

### Drivers:

#### CODE:

- 851993 Anvil System Driver LED Line 23W-45W 450mA 230V
- 851994 Anvil System Driver LED Line DIM 1/10V - 15W-45W 450mA 230V
- 851995 Anvil System Driver LED Line DIM PUSH - DALI 23W-45W 450mA 230V
- 851997 Anvil System Driver LED Line 21W 450mA 110-230V
- 851998 Anvil System Driver LED Line DIM 1/10V 23W 450mA 110-230V
- 851999 Anvil System Driver LED Line DIM PUSH - DALI 21W 450mA 230V

#### Light source:

#### CODE:

- 851840C Anvil System LED Line C420 Surface/Recessed
- 851840S Anvil System LED Line S420 Suspension

LED Line (LED included) **A+**

LED 7,8W 1260lm 450mA 3000K CRI80

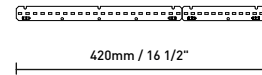

#### CODE:

- 851850C Anvil System LED Line C560 Surface/Recessed
- 851850S Anvil System LED Line S560 Suspension

LED Line (LED included) **A+**

LED 10,5W 1590lm 450mA 3000K CRI80

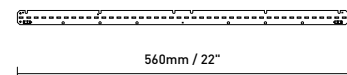

#### CODE:

- 851860C Anvil System LED Line C700 Surface/Recessed
- 851860S Anvil System LED Line S700 Suspension

LED Line (LED included) **A+**

LED 13,1W 2010lm 450mA 3000K CRI80

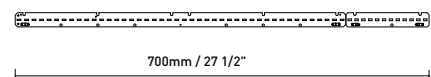

#### CODE:

- 851870C Anvil System LED Line C840 Surface/Recessed
- 851870S Anvil System LED Line S840 Suspension

LED Line (LED included) **A+**

LED 15,7W 2430lm 450mA 3000K CRI80

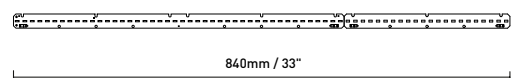

#### CODE:

- 851880C Anvil System LED Line C1120 Surface/Recessed
- 851880S Anvil System LED Line S1120 Suspension

LED Line (LED included) **A+**

LED 21W 3180lm 450mA 3000K CRI80

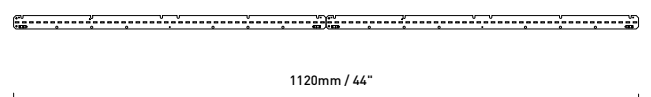



Lense 38°

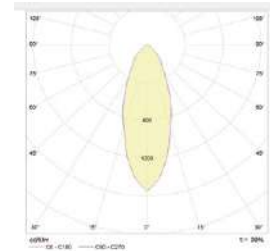

Lense 60°

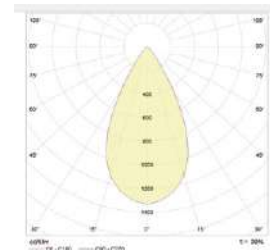

### Anvil System LED Module

LED module equipped with four or two spots, for integration into the Anvil System. Finishes: matte white or matte black.

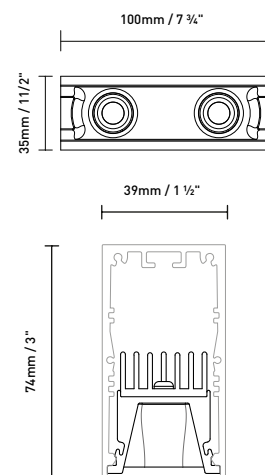
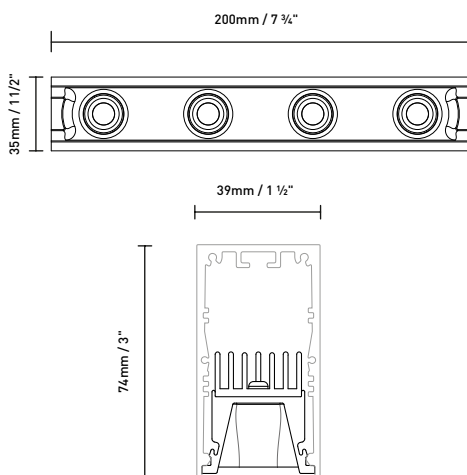

#### CODE:

- 851600 Anvil System LED Module 4 38° Black
- 851601 Anvil System LED Module 4 38° White
- 851610 Anvil System LED Module 4 60° Black
- 851611 Anvil System LED Module 4 60° White

#### CODE:

- 851620 Anvil System LED Module 2 38° Black
- 851621 Anvil System LED Module 2 38° White
- 851630 Anvil System LED Module 2 60° Black
- 851631 Anvil System LED Module 2 60° White

#### Light source:

- LED Module (LED included) A+ 
- LED 4 x 4,5W 2184lm 250mA 3000K CRI80
- Lense: 38°, 60°

#### Light source:

- LED Module (LED included) A+ 
- LED 2 x 4,5W 1092lm 250mA 3000K CRI80
- Lense: 38°, 60°

#### Drivers:

##### CODE:

- 851996 Anvil System Driver LED Module 18W-54W 250mA 230V
- 851991 Anvil System Driver LED Module DIM 1/10V 9W-72W 250mA 230V
- 851992 Anvil System Driver LED Module DIM PUSH - DALI 36W-54W 250mA 230V
- 851989 Anvil System Driver LED Module DIM PUSH - DALI 13,5W - 18W 250mA 230V



### Light source:

LED Spot (LED and driver included)

**A+**



LED 4,5W 546lm 250mA 3000K CRI80 230V

Lense: 38°, 60°

Lense 38°

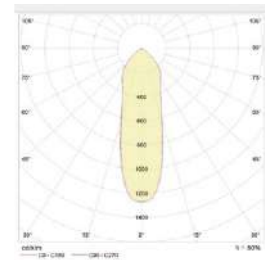

Lense 60°

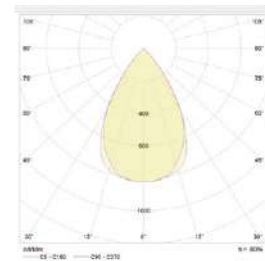

### Anvil System LED Spotlight

LED projectors of different sizes (S, M, L), for integration into the Anvil System. Finishes: matte white or matte black.

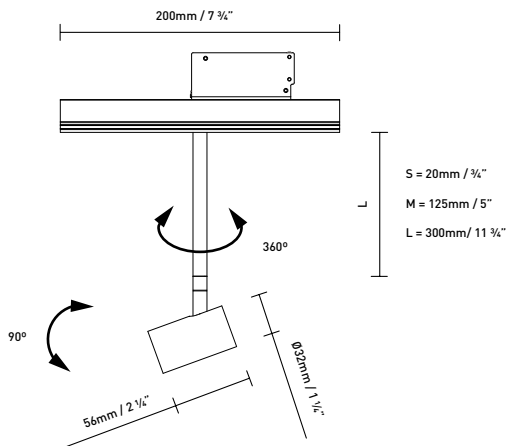

### CODE:

- 851700 Anvil System Spotlight S-38° Black
- 851701 Anvil System Spotlight S-38° White
- 851702 Anvil System Spotlight S-60° Black
- 851703 Anvil System Spotlight S-60° White
- 851710 Anvil System Spotlight M-38° Black
- 851711 Anvil System Spotlight M-38° White
- 851712 Anvil System Spotlight M-60° Black
- 851713 Anvil System Spotlight M-60° White
- 851720 Anvil System Spotlight L-38° Black
- 851721 Anvil System Spotlight L-38° White
- 851722 Anvil System Spotlight L-60° Black
- 851723 Anvil System Spotlight L-60° White

### Accessories:

#### CODE:

- 851790 Anvil System Spotlight Anti-Glare Ring Black
- 851791 Anvil System Spotlight Anti-Glare Ring White

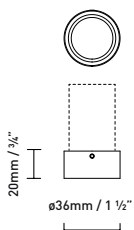

#### CODE:

- 851792 Anvil System LED Spot Ring + Honeycomb Black
- 851793 Anvil System LED Spot Ring + Honeycomb White

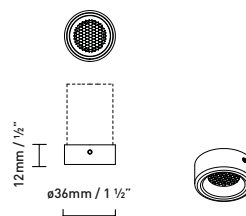



◇ **Light source:**

LED Spot (LED and driver included) **A+**



LED 4,5W 546lm 250mA 3000K CRI80 230V

Lens: 38°, 60°

Lenze 38°

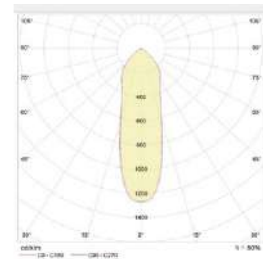

Lenze 60°

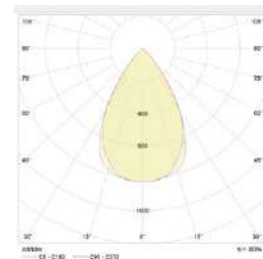

### Anvil System LED Spot S

Suspended LED projectors for Anvil System. Finishes: matte white or matte black.

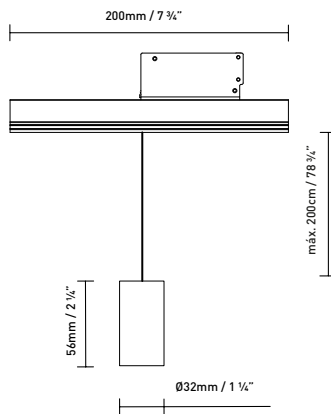

**CODE:**

- 851750 Anvil System LED Spot S-38° Black
- 851751 Anvil System LED Spot S-38° White
- 851752 Anvil System LED Spot S-60° Black
- 851753 Anvil System LED Spot S-60° White

### Accessories:

**CODE:**

- 851790 Anvil System Spotlight Anti-Glare Ring Black
- 851791 Anvil System Spotlight Anti-Glare Ring White

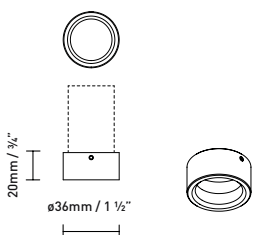

**CODE:**

- 851792 Anvil System LED Spot Ring + Honeycomb Black
- 851793 Anvil System LED Spot Ring + Honeycomb White

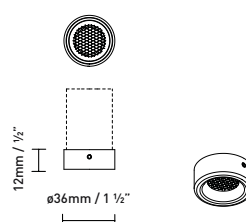





Light source:

Sphere C (LED included)

A+

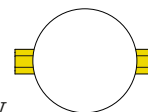

LED 3,2W 350lm 350mA 3000K CRI80 110-230V

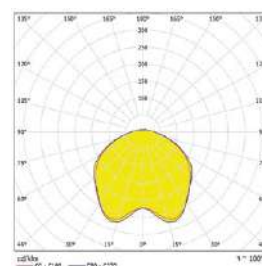

### Anvil System Sphere C

White, opal glass spherical diffuser attached to the Anvil System rail. Metal parts finished in matte white or matte black.

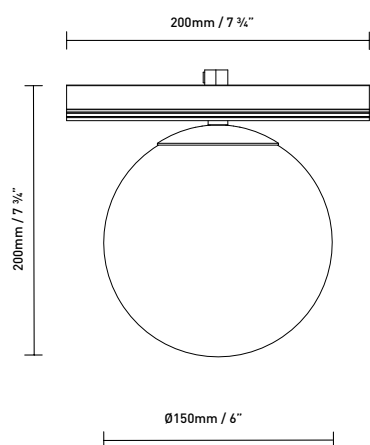

CODE:

851730 Anvil System Sphere C Black

851731 Anvil System Sphere C White



Light source:

Sphere S (LED included)

A+

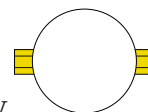

LED 3,2W 350lm 350mA 3000K CRI80 110-230V

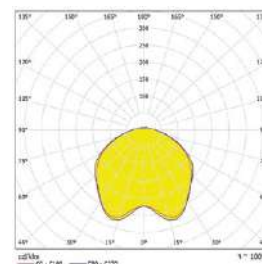

### Anvil System Sphere C

White, opal glass spherical diffuser attached to the Anvil System rail. Metal parts finished in matte white or matte black.

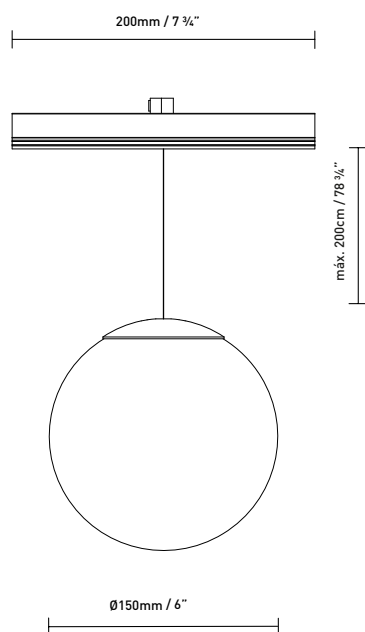

CODE:

851740 Anvil System Sphere S Black

851741 Anvil System Sphere S White



CODE:

851960 Anvil System Cover Profile Black (1M)

851961 Anvil System Cover Profile White (1M)

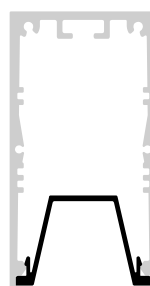
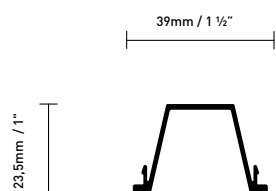

CODE:

851970 Anvil System Flat Cover Profile Black (1M)

851971 Anvil System Flat Cover Profile White (1M)

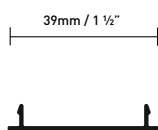

CODE:

851930 Anvil System 180° Angle

180°

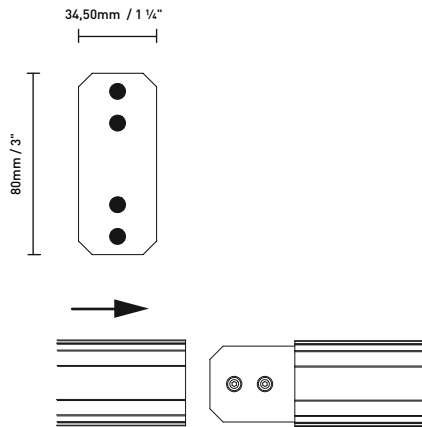

CODE:

851920 Anvil System 135° Angle Black

851921 Anvil System 135° Angle White

851925 Anvil System 135° Angle Recessed Black

851926 Anvil System 135° Angle Recessed White

135°

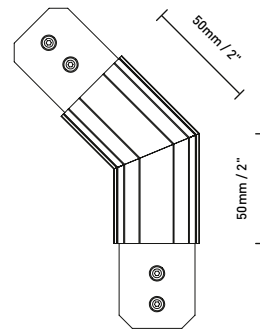

CODE:

851910 Anvil System 90° Angle Black

851911 Anvil System 90° Angle White

851915 Anvil System 90° Angle Recessed Black

851916 Anvil System 90° Angle Recessed White

90°

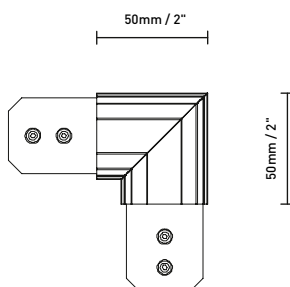

\*Special angles, under request

CODE:

851900 Anvil System End Cap Black (2 un.)  
851901 Anvil System End Cap White (2 un.)

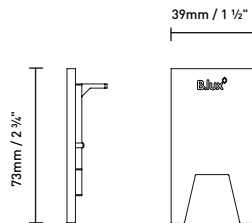

CODE:

851908 Anvil System Recessed End Cap Black (2 un.)  
851909 Anvil System Recessed End Cap White (2 un.)

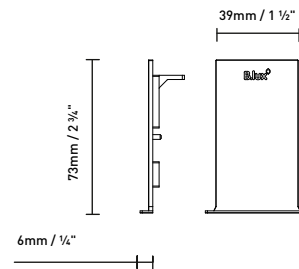

CODE:

851906 Anvil System LED End Cap Black (2 un.)  
851907 Anvil System LED End Cap White (2 un.)

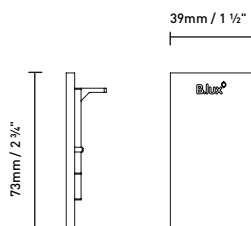

CODE:

851905 Anvil System Wall fixation

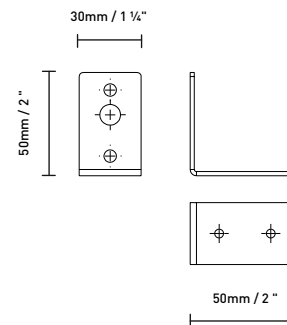

CODE:

851980 Anvil System Current Supply Black  
851981 Anvil System Current Supply White  
851985 Anvil System DIM Current Supply Black  
851986 Anvil System DIM Current Supply White

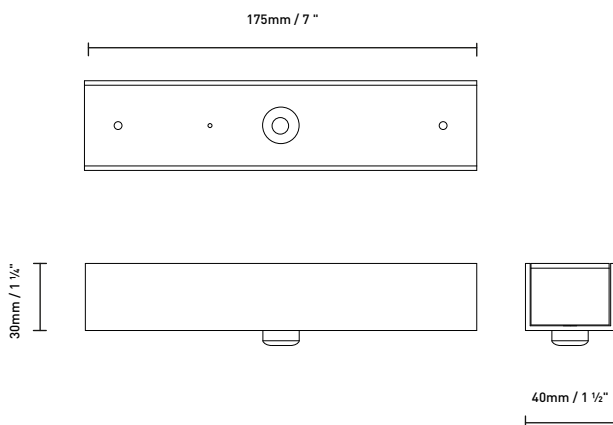

CODE:

851990 Anvil System Single Suspension



Do it yourself

1. Define the dimensions.

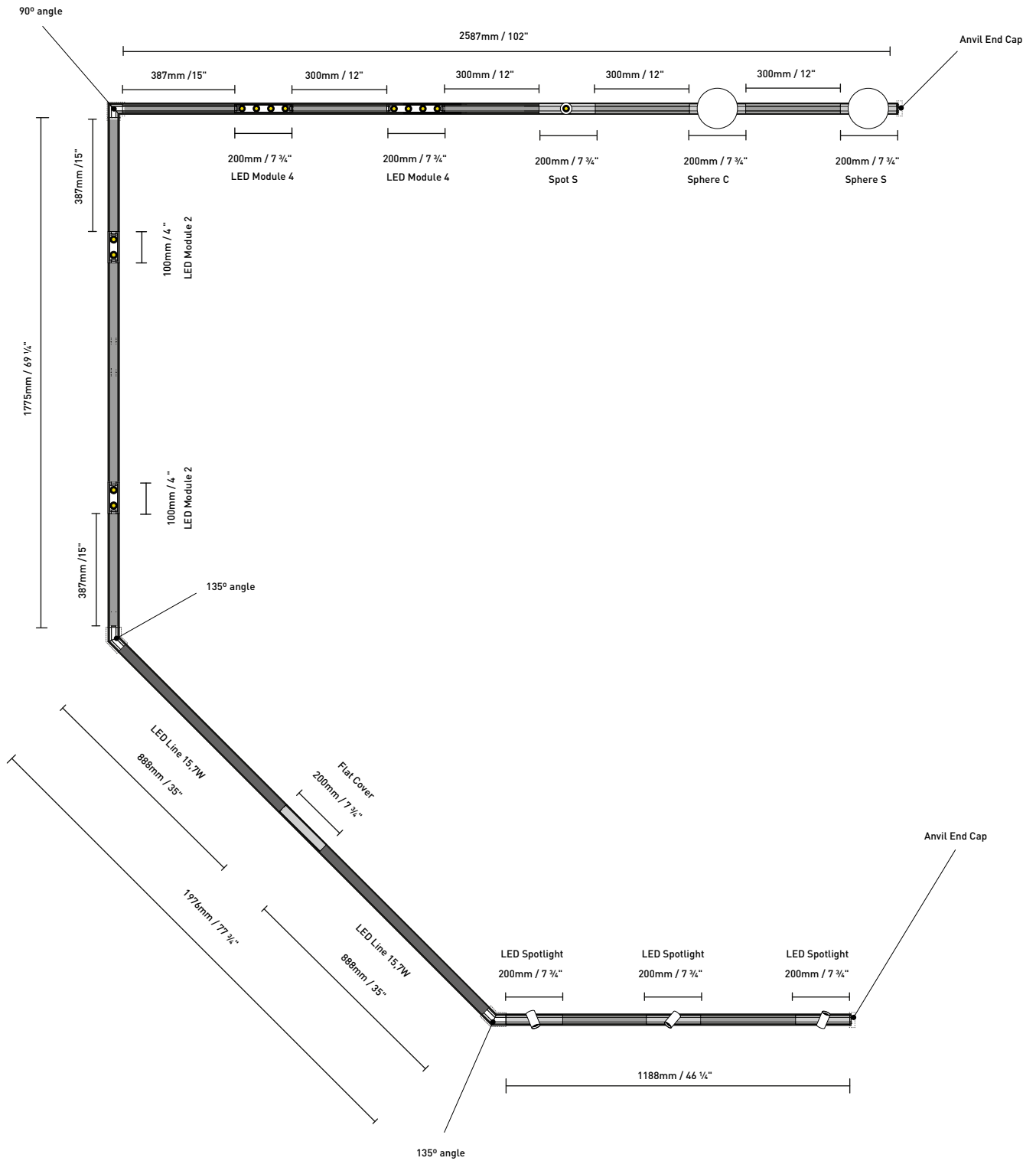

Do it yourself

2. Choose the profile and the version.

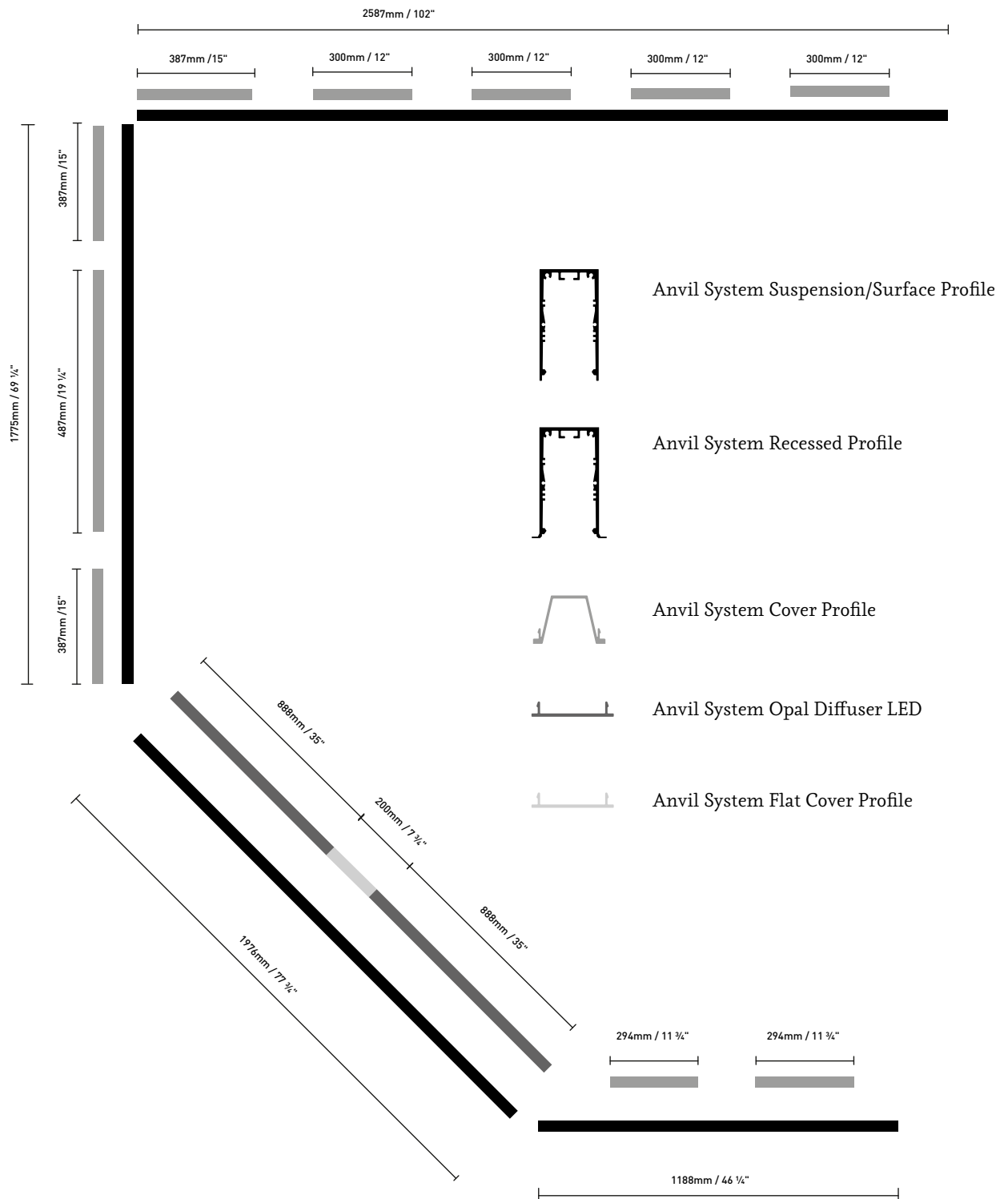

Do it yourself

3. Choose the joints.

Anvil System 180° Angle

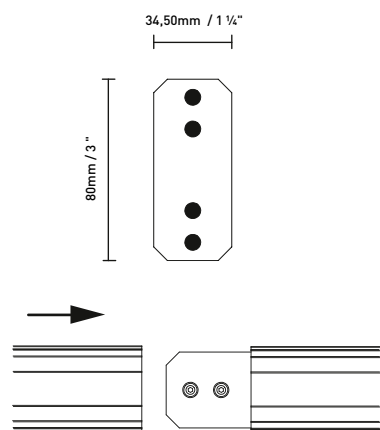

Anvil System 90° Angle

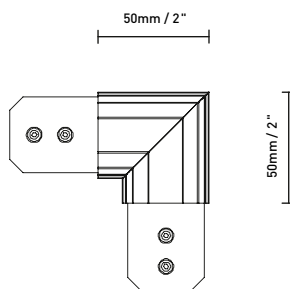

Anvil System 135° Angle

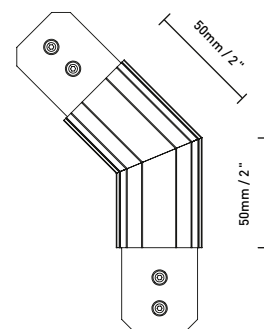

4. Choose the final cover.

4.a. Anvil System Surface End Cap

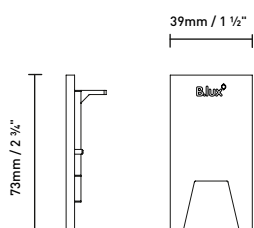

4.c. Anvil System Wall fixation

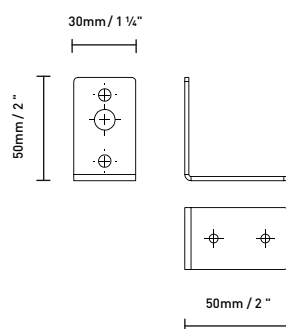

4.b. Anvil System Surface LED End Cap

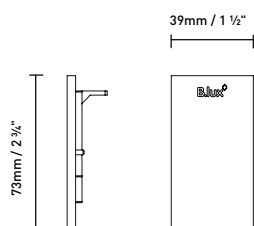

4.d. Anvil System Recessed End Cap

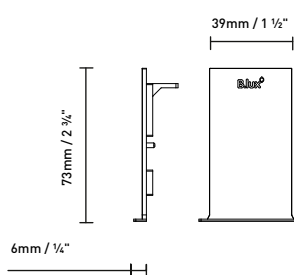



### Do it yourself

#### 5. Choose the function.

##### 5.a. Suspension

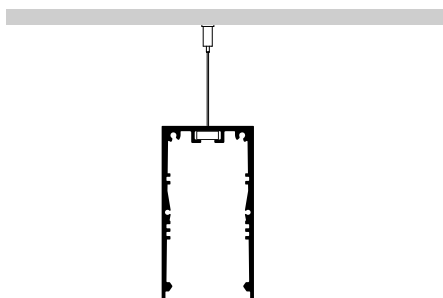

##### 5.c. Recessed

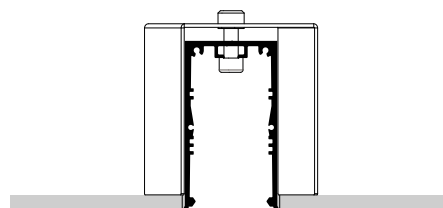



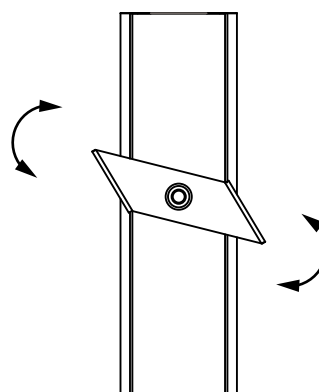
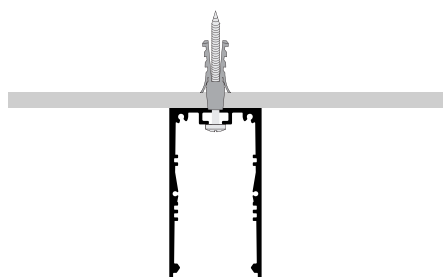

##### 5.b. Surface



#### 6. Choose the light source.

##### Light source:

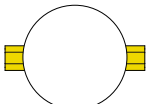
LED Line (LED included)	<b>A+</b>	
LED Module 4/2 (LED included)	<b>A+</b>	
LED Spotlight (LED included)	<b>A+</b>	
LED Spot (LED included)	<b>A+</b>	
Sphere C/S (LED included)	<b>A+</b>	

#### 7. Dimming options.

1-10V

Push DIM

DALI Control

Do it yourself

8. Define the circuits.

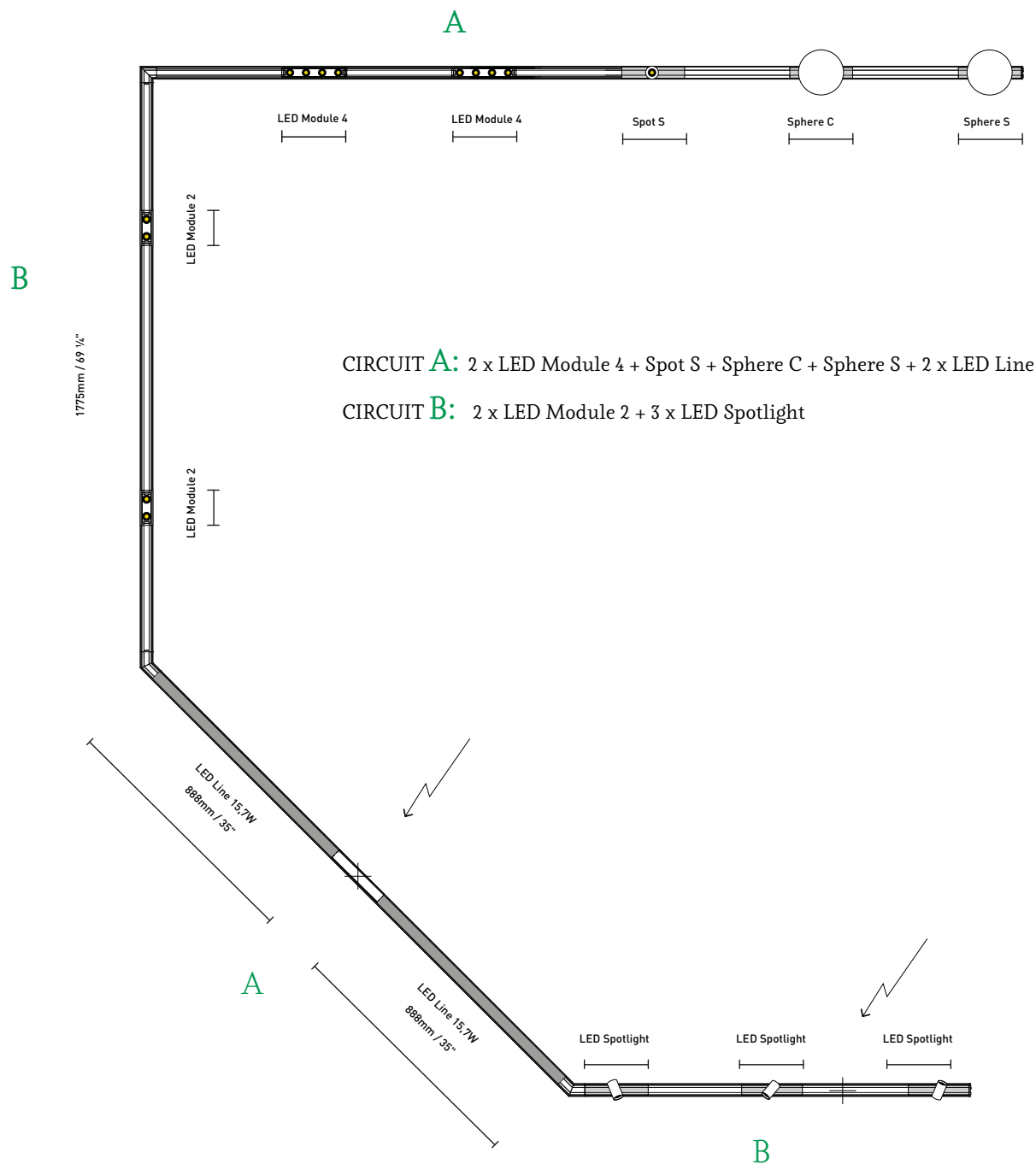

Do it yourself

9. Define the current supply.

Anvil System Current Supply  
Anvil System DIM Current Supply

Anvil System Single Suspension

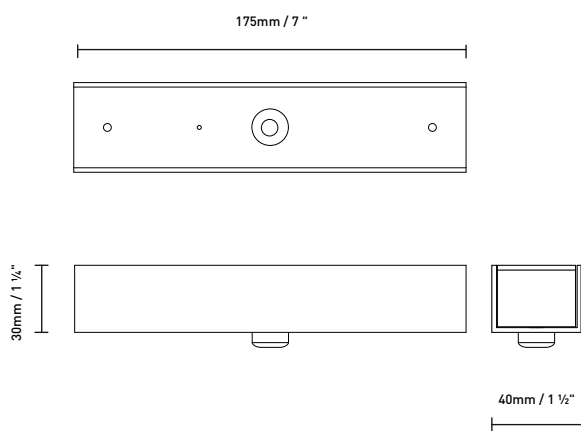

# B.lux

**B.LUX S.A.**

Pal. Ind. Okamika, pab. 1  
48289 Gizaburuaga (Bizkaia)  
SPAIN

T. (+34) 94 682 72 72

F. (+34) 94 682 49 02

[info@grupoblux.com](mailto:info@grupoblux.com)

[www.grupoblux.com](http://www.grupoblux.com)